

Draught & Weather Solutions



Get in touch with our sales and technical team for more information:

Tel: **01329 844 500**

Email: **sales@astrodraft.com**

Web: **www.astrodraft.com**

Scan to view
the full range
of products



SCAN ME

SASH WINDOW & PATIO DOOR SEALS

Replacement and retrofit sash window seals and patio door seals to weatherproof, draughtproof, conserve energy and reduce intrusive noise.

SASH WINDOW PARTING BEAD SEALS

> Product Description

A durable seal designed for verticals of timber box sash windows. With a single hinge and two independently acting flippers. Smooth moving friction free flippers unaffected by paint or stains. It can be used as a direct fit in an 8mm groove or in conjunction with our 10 x 10 carrier.

A = Groove size: 8mm
 B = Groove size: 8mm (min)
 C = Height: 17mm
 D = Suits gaps: 10mm - 13mm
 3m lengths
 To order, quote Ref No. White - ADPB01WX Brown - ADPB02BX



PARTING BEAD BRUSH SEAL

> Product Description

This solid design of parting bead provides an excellent durable bead that can be used as a direct fit in an 8mm groove or in conjunction with our 10x10 channel. Options: White seal / white brush or Brown seal / brown brush.

A = Groove size: 8mm
 B = Groove size: 8mm (min)
 C = Height: 16mm
 D = Width: 14mm
 Db Brush pile 8.5mm: suits gaps 10 - 13mm
 3m lengths
 To order, quote Ref No. White - ADPBBW Brown - ADPBBB

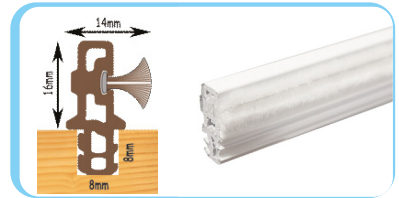

PARTING BEAD CARRIER

> Product Description

If groove size is a problem try this 10x10mm Parting Bead Channel / Carrier for use with 8mm direct fit parting beads. Will take 8mm Direct Fit or Double Flipper Parting Bead.

A = Groove size: 10mm
 B = Groove size: 10mm
 3m lengths
 To order, quote Ref No. White - ADPB0W Brown - ADPB0B

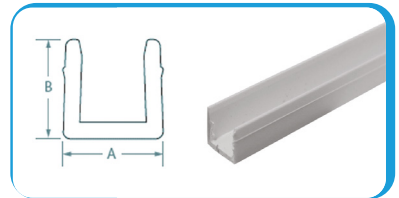

IMPLY

> Product Description

A spring seal for either surface mounting or inset. This product is often used as a mid-rail seal and for the top and bottom rail of sliding windows.

A = Kerf size: 2.5 to 3mm
 B = Kerf size: 6mm (min)
 C = Suits gap 2 : 6.5mm
 D = Flipper length: 6.5mm
 E = Base length: 9.5mm
 2.2m lengths, To order, quote Ref No. White - ADIMPLYW Brown - ADIMPLYB

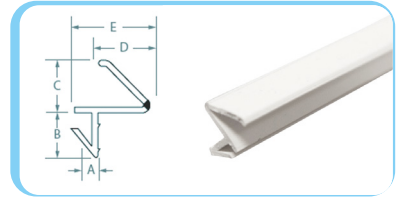

ASTRO CARRIPILE CP SEAL

Used as an alternative to ImPLY. Ideal for top, bottom and meeting rails of patio doors. Supplied with a standard pile length of 6mm to suit gaps 2 - 3.5mm.

CP2

> Product Description

Ideal for top, bottom and meeting rails of patio doors etc. Centre leg carrier for mechanical fitting into grooved frames. Supplied with a standard pile length of 6mm to suit gaps 2 - 3.5mm. Longer length brushes available on application.

A = Kerf size: 2.7mm
 B = Kerf size: 3mm (min)
 C = Groove size: 6mm
 D = Groove size: 8mm
 2.2m lengths. To order, quote Ref No. White - ADCP2W Brown - ADCP2B. State length of brush required.

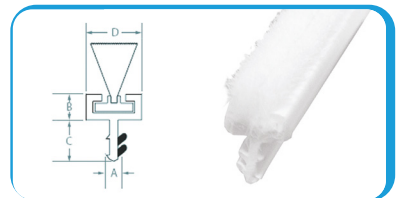

> How to order:

T: 01329 844 500 | E: SALES@ASTRODRAFT.COM

> For more information:

WWW.ASTRODRAFT.COM

DOOR & GLAZING SEALS

Easy fit compression seals for draught and weather sealing doors and windows. Suitable for all types of doors and windows and void filling.

E PROFILE DOOR/GLAZING SEAL

> Product Description

Brown or White 9mm x 4mm 5M, 10M & 100M coils.

To order, quote Ref No.

White [5M, 10M & 100M] - ADESW/5 | ADESW/10 | ADESW/100

Brown [5M, 10M & 100M] - ADESB/5 | ADESB/10 | ADESB/100



P PROFILE DOOR/GLAZING SEAL

> Product Description

Black, Brown or White 9mm x 5.5mm 5M & 100M coils.

To order, quote Ref No.

White [5M & 100M] - ADPSW/5 | ADPSW/100

Brown [5M & 100M] - ADPSB/5 | ADPSB/100

Black [5M & 100M] - ADPSBLK/5 | ADPSBLK/100



DOOR BOTTOM SEALS

ASTRO WEATHERSTOP WS SEAL

> Product Description

This weatherbar offers an improved weather performance over galvanised and plain plastic alternatives in the market and, with a built-in flexible flipper that will offer excellent long last protection. Its robust design will withstand the extremes of weather conditions and general foot traffic.

Suits Gaps: 2mm - 6mm. Lengths of 3m or 914mm

To order, quote Ref No.

Brown - ADWS04BX/3000 (3m) or ADWS04BX/914 (914mm)

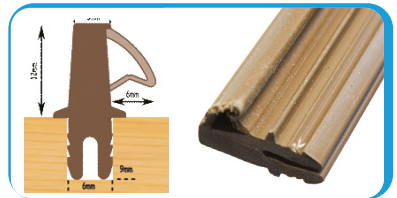

ASTRO H CARRIER

> Product Description

A superior quality brush seal for draught proofing and weather sealing door base. Black nylon brush piles in 22mm, 30mm, 40mm or 50mm brush depth. Brush strip is available in 914mm or 2134mm dimensions. Easily trimmed to exact door width.

To order, quote Ref No.

ADHCAR | Colour [M or G] | Lengths [914 or 2134] | Brush Length [22 to 50]

ADHCARM914/22



> How to order:

T: 01329 844 500 | E: SALES@ASTRODRAFT.COM

> For more information:

WWW.ASTRODRAFT.COM

SCHLEGEL AQUAMAC DRAUGHT PROOFING FOR TIMBER DOORS & WINDOWS



> The Aquamac Range

Schlegel - AQUAMAC Weatherseal for timber windows and doors. The only non-rot weatherseal specifically for timber windows and doors AQUAMAC weatherseal has been developed in consultation with Schlegel customers to offer the widest range of seals possible for timber windows and doors.

The unique design has made Aquamac impervious to paint and stain, while still providing some of the best energy saving performance characteristics currently available.

B = Brown W = White BLK = Black

> Aquamac Features

- Backed by a LIFETIME GUARANTEE.
- Conforms to BS644/BBA approved.
- Excellent memory - retains its original shape for a consistent weatherseal.
- Exceptional performance maintained over a wide temperature range.
- Immune to the effects of UV light & ozone.
- IMPERVIOUS TO PAINT AND STAIN
- Water repellent foam is unaffected by rot, mould or mildew.

SCHLEGEL REBATED RANGE

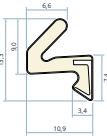
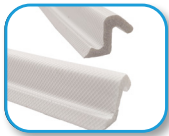

AM21/QL3009

Available only as a coil in 100 metre or 250 metre lengths. ADAM21/Colour

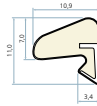

AM4846/QL3037

Available only as a coil in 100 metre or 200 metre lengths ADAM4846/Colour

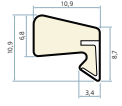
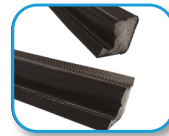

AM109/QL3011

Available only as a coil in 100 metre or 250 metre lengths ADAM109/Colour

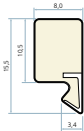

AM33/QL3012

Available only as a coil in 100 metre or 200 metre lengths ADAM33/Colour



AM63/QL3005

Available only as a coil in 100 metre or 300 metre lengths ADAM63/Colour



AM48/QL3013

Available only as a coil in 100 metre or 350 metre lengths ADAM48/Colour

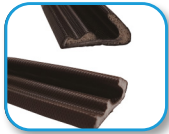

AM124/QL3020

Available only as a coil in 100 metre lengths ADAM124/Colour

> How to order:

T: 01329 844 500 | E: SALES@ASTRODRAFT.COM

> For more information:

WWW.ASTRODRAFT.COM

SCHLEGEL RETRO FIT RANGE

> Schlegel Features

■ Q-Lon Seal Performance
not affected by painting over

■ 7386 conformity : BS5750 quality guaranteed
■ Low Friction
■ 10 Year Life Span

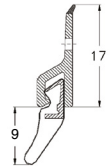
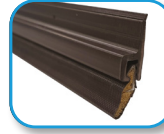
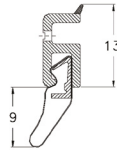
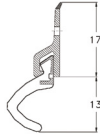

QLON RETRO 21 L

Exterior door seal. Particularly useful when exterior doors are exposed to severe weather conditions.

ADAMRET21LB - Brown Q-Lon seal / Brown PVC-u Carrier - 2050mm
ADAMRET21LW - White Q-Lon seal / White PVC-u Carrier - 2050mm

Q-LON SBS

Where fixing area is narrow on head and jambs of timber doors, perimeters of timber casement window, casement windows. Vertical timber sliding sash windows.

ADAMQLSBSB - Brown Q-Lon seal / Brown PVC-u Carrier - 2050mm

Q-LON PS

Perimeter of timber casement windows. Vertical sliding sash timber windows. Head and jamb of internal timber doors. Loft hatches and trap doors.

ADAMQLPSB - Brown Q-Lon seal / Brown PVC-u Carrier - 2050mm

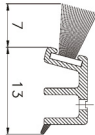

SHARKSEAL SBS

Where fixing area is narrow on head and jambs of timber doors, perimeters of timber casement windows and vertical sliding sash timber windows.

ADAMSBSB - Brown Q-Lon seal / Brown PVC-u Carrier - 2050mm

> How to order:

T: 01329 844 500 | E: SALES@ASTRODRAFT.COM

> For more information:

WWW.ASTRODRAFT.COM

ACOUSTIC DOOR BOTTOM SEALS

RP35Si

> Product Description

An adjustable, automatic door bottom seal, spring loaded to lift clear of the floor when the door is opened. Acoustically designed and features silicon gaskets for medium temperature smoke and fire door applications. Operated automatically by pressure against the door jamb or stop on its adjustable strike. Design for Access and Mobility. High efficiency mechanism to assist with closing force requirements. Location: Face mounted or semi-morticed into the bottom of solid core single and double butt hinged doors.

The RP35Si can also be face mounted to the bottom of metal doors. Min/Max Gap: 3mm to 13mm. Finish: Satin clear (silver) anodised aluminium (15µm). Fixing: Concealed screw fix. Zinc plated, cross recess head S.T. screws, colour matched escutcheon plates and cover strip supplied. Fixing holes are pre-slotted. Seal: RP308Si. Grey silicon rubber (SE). Sizes: 1220mm, 1070mm, 920mm, 820mm, 600mm, 380mm to 295mm (min). Seals cut back to exact size.

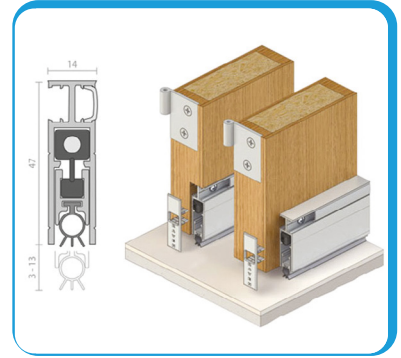

DOOR BOTTOM SEALS

RP60 (RESIDENTIAL)

> Product Description

A self levelling, face mounted, automatic door bottom seal spring loaded to lift clear of the floor as soon as the door leaf is opened by a few millimetres. It is operated automatically by pressure against the door jamb on its adjusting screw, and it incorporates concealed fixings.

Location: Face mounted on the bottom of single and double butt hinged doors. Min/Max Gap: 3mm to 15mm. Finish: Satin clear (silver) anodised aluminium (15µm). Fixing: Concealed screw fix. Zinc plated, cross recess head S.T. screws and cover strip supplied. Fixing holes are pre-slotted. Seal: RP460. Black TPE. Sizes: 915mm maximum (between door stops). Unit cuts back to 450mm (min)

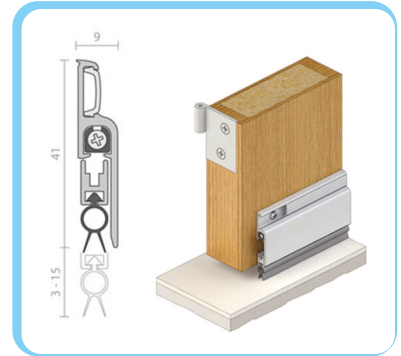

RP26

> Product Description

A heavy duty sweep seal for door bottoms of outward opening doors. Slotted fixing holes allow for adjustment all concealed behind a push in cover strip. The RP26 is ideal for use in conjunction with Raven threshold plates eg RP19, 28, 29. Replacement Seal RP326.

Location: Bottom of single and double, outward opening, butt hinged doors, tilt up doors or can be used as an astragal seal. Min/Max Gap: 5mm to 20mm (user determined). Finish: Satin clear (silver). Fixing: Concealed screw fix. Zinc plated, cross recess head S.T. screws and cover strip supplied. Fixing holes are pre-slotted. Seal: RP326. Black EPDM. Seal Sizes Available: in 1000mm and 2000mm stock lengths.

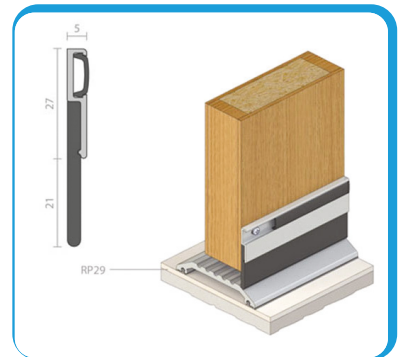

> How to order:

T: 01329 844 500 | E: SALES@ASTRODRAFT.COM

> For more information:

WWW.ASTRODRAFT.COM

DOOR PERIMETER SEALS

RP118Si

> Product Description

A smoke, weather and acoustic door frame seal suitable for outward opening butt hinged doors. Designed to accommodate a latch engagement for suitable panic exit devices at the head of the door. The RP118Si used in conjunction with the RP117Si threshold plate seal provides a bulkhead seal around the door with a top and bottom latch engagement. Quick and easy to install with a mitre joint without removing the door, the RP118Si is slotted

for adjustment and has concealed fixings. Location: Head and jambs of single and double butt hinged doors. Min/Max Gap: 0mm to 10mm. Finish: Aluminium anodised 15 microns. Satin Clear (Silver) finish. Fixing: Screw fix. Zinc plated, cross recess head S.T. screws and cover strip supplied. Seal: RP308Si. Grey silicon rubber (SE). Sizes: Available in 1000 and 2000mm stock lengths.

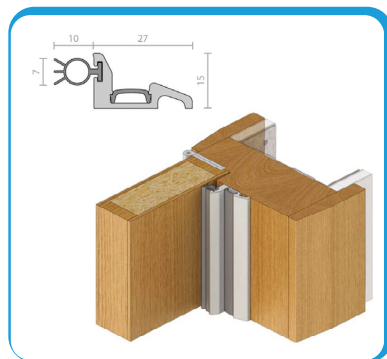

RP12 NOISE AND DUST CONTROL SEAL

> Product Description

The RP12 has a woven pile weather strip with unique Quiet-fins for noise protection. Ideal for sliding doors and designed to limit noise leakage and control dust and air movement. The RP12 is quick and easy to install to the door or frame. Can be used in conjunction with a double row of RP2 seals fitted into grooves in the door bottom edge or face mount RP74 to achieve a complete sealing system.

Location: Head and jambs of door frames. Min/Max Gap: 6mm to 8mm (prior to installation). Finish: Aluminium anodised 15 microns. Satin Clear (Silver). Fixing: Concealed screw fix. Zinc plated, cross recess head S.T. screws and cover strip supplied. Fixing holes are pre-slotted to allow the seals to be fitted accurately and adjustment to be made for building movement. Seal: Black polypropylene pile with felt weather fins.

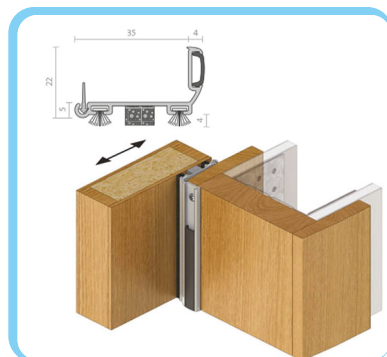

GLASS DOOR SEALS

RP79/RP88

> Product Description

Aluminium astragal seals designed for frameless glass doors. The woven pile sealing strip is combined with a weather fin to form an effective weather and energy seal. Both types, RP79 and RP88, are for pre-installation gaps of 8mm to 9mm and sold in 3 metre lengths. Fixing is with double sided adhesive tape (pre-fitted in the carrier). Contact surfaces must be clean, smooth and, if painted, well cured. Use in conjunction with Raven brush strip door bottom seals RP2b, RP74 and threshold plates. To seal the bottom of the door we suggest the Raven RP74 or

RP75 Self Adhesive Brush Seals. Location: Meeting stiles of 12mm thick frameless glass doors. Min/Max Gap: 8mm to 9mm (prior to installation). Finish: Satin clear (silver) anodised aluminium (15µm). Fixing: Self adhesive. Note: Contact surface must be clean, smooth and if painted, well cured. Self adhesive seals will not adhere to oiled or alkyd finishes or to easy clean wash and wear paint surfaces. Seal: Black polypropylene pile with felt weather fins. Sizes: 12mm or 10mm thick glass - 3000 mm



> How to order:

T: 01329 844 500 | E: SALES@ASTRODRAFT.COM

> For more information:

WWW.ASTRODRAFT.COM

THRESHOLD PLATES

RP13

> Product Description

A low profile threshold plate that is ideal for use in conjunction with Raven door bottom seals to prevent rain, draughts, noise and smoke infiltration. Location: Door sill. Standard Finish: Aluminium anodised 25 microns. Satin Clear (Silver).

Fixing Method: Zinc plated, cross recess head CSK S.T. screws of the appropriate size and colour are supplied, or can be fastened with adhesive. Sizes: Available in 1000mm and 2000mm stock lengths.

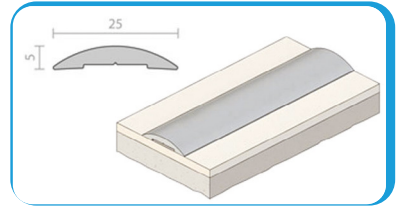

RP77

> Product Description

A heavy duty threshold ramp with a ribbed design which can be positioned back to back to form a two way threshold ramp conforming to NCC Pt. D2.15 Thresholds (b). Can be used in conjunction with Raven door bottom seals to prevent rain, draughts, noise and smoke infiltration. Suitable for use with most floor pivots. Ideal for commercial shop fronts providing a neat ramp detail between carpets or tiles at door ways.

Can also be used to provide a ramped frame for internal door mats. For a threshold ramp plate with a longer slope see the Raven RP98 model. Location: Door sill. Finish: Aluminium anodised 25 microns. Satin Clear (Silver). Fixing: Zinc plated, cross recess head CSK S.T. screws of the appropriate size and colour are supplied. Sizes: 1000mm, 2000mm and 2250mm stock lengths.

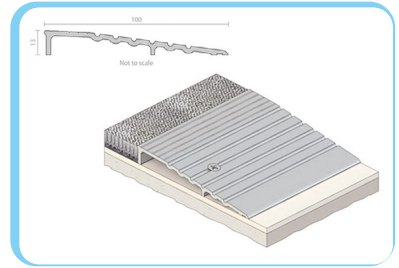

RP98

> Product Description

A heavy duty threshold ramp with a ribbed design which can be positioned back to back to form a two way threshold ramp conforming to NCC Pt. D2.15 Thresholds (b). Can be used in conjunction with Raven door bottom seals to prevent rain, draughts, noise and smoke infiltration. Suitable for use with most floor pivots. Ideal for commercial shop fronts providing a neat ramp detail between carpets or tiles at door ways. Can also be used to provide a ramped

frame for internal door mats. Location: Door sill. Finish: Aluminium anodised 25 microns. Satin Clear (Silver) finish. Fixing: Screw fix. Zinc plated, cross recess head CSK S.T. screws supplied. Can be fastened with builders adhesive for concealed fixing. Dimensions: max height 19mm, ramp length 150mm. For a shorter ramp length see the Raven RP77 threshold plate. Specify longer length than doorway to allow for neat installation around door frame.

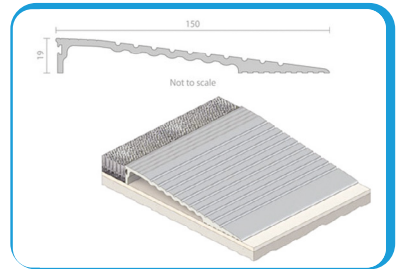

RP66

> Product Description

A flush fitting threshold plate for carpet covered floors. RP66 has concealed fixings with self adhesive aluminium insert. Location: Door sill. Sizes: Available in 1000mm and 2000mm stock lengths. Standard Finish: Aluminium anodised 25 microns. Satin Clear (Silver). Fixing Method: Zinc plated, cross recess head CSK S.T. screws of the appropriate

size and colour are supplied, or can be fastened with adhesive. Use in conjunction with a Raven door bottom seal such as RP38 Si to provide an optimum sealing surface, as carpets can flatten and thus reduce sealing effectiveness.

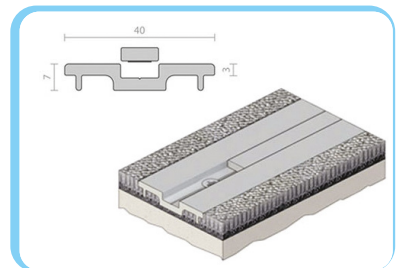

> How to order:

T: 01329 844 500 | E: SALES@ASTRODRAFT.COM

> For more information:

WWW.ASTRODRAFT.COM

MAGNETIC SEALS

RP39

> Product Description

A refrigeration type vinyl magnetic strip in an anodised aluminium housing. RP39 provides a tight seal for steel clad doors and jambs and may be used as a stop. For timber doors, a thin steel strip can be attached to the door face. The magnetic strip has sufficient closing strength that latches may not be required. It can also be used in pairs on meeting stiles of timber doors. Note: As an astragal seal, RP39 is best suited to infrequent use

and door closer hold open applications. Location: Head, jambs and stiles of single and double butt hinged doors, sliding doors or bulkhead applications. Min/Max Gap: 4mm to 8mm (meeting stiles). Finish: Satin clear (silver) anodised aluminium (15µm). Fixing: Screw fix. Zinc plated, cross recess head S.T. screws supplied. Fixing holes are slotted. Seal: Black PVC. Sizes: Available 2500mm lengths.

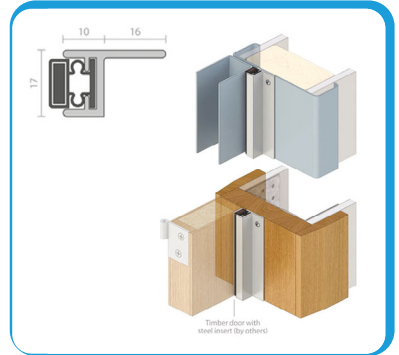

SELF ADHESIVE SEALS

RP48

> Product Description

Available in white or brown. Location: Perimeter of doors and windows. Min/Max Gap: 3mm to 5mm (user determined). Seal Sizes: 6m coil pack length (2x3m).



RP59

> Product Description

Available in white or brown. Location: Perimeter of doors and windows. Min/Max Gap: 2/4mm (user determined). Seal Sizes: 6m coil pack length (2x3m).



RP61

> Product Description

A self adhesive soft woven pile draught seal which is ideal for sliding door and window applications. Location: Perimeter of doors and windows. Min/Max Gap: 3mm to 5mm (user determined). Fixing: Self adhesive. Note: Contact surface must be clean, smooth and if painted, well cured. Seal: Grey polypropylene. Sizes: 5m coil.



RP108

> Product Description

RP108 is a multi purpose, user determined self adhesive EPDM compression seal. Location: Multi-purpose (user determined). Min/Max Gap: 6mm to 8mm (user determined). Fixing: Self adhesive. Note: Contact surface must be clean, smooth and if painted, well cured. Seal: Grey or White EPDM closed cell sponge. Sizes: 2m coil pack.



> How to order:

T: 01329 844 500 | E: SALES@ASTRODRAFT.COM

> For more information:

WWW.ASTRODRAFT.COM

DOOR SEALS



BOTTOM DOOR SEALS

> Product Description

A bottom door seal that can seal gaps up to 25mm. The seal is available in various colours and comes in 914mm or 2134mm lengths, which can be cut to your size requirement. This bottom seal is perfect for sliding, folding, hinged and garage doors. This seal comes complete with screw fixings

Available in White, Brown, Aluminium and Gold colour. 914mm or 2134mm lengths



HEAVY DUTY AROUND THE DOOR SEALS

> Product Description

Heavy duty screw fix seal by Stormguard is a seal for around doors. Draught proofing strips bridge the gap between the door and the frame and wind pressure increases the efficiency of the system. The seal is available in various colours and comes in 2057mm Kits (2 x 2057mm / 1 x 914mm), which can be cut to your size requirement. This door seal is perfect for Inward Opening Doors and comes complete with screw fixings

Available in Aluminium or Gold colour
Sold in 2057mm Kits (2 x 2057mm / 1 x 914mm)

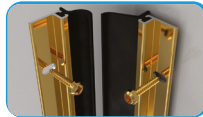

SELF ADHESIVE SEALS

SELF ADHESIVE EXTRA THICK SEALS

> Product Description

An extra thick door or window foam seal by Stormguard that can seal larger gaps. The seal is available in various colours and comes in 3.5 metre lengths. Excellent memory, returns back to its original shape after compression.

12.7mm x 8mm
Available in White, Black or Brown colour.
Sold in packs of 3.5 metre lengths

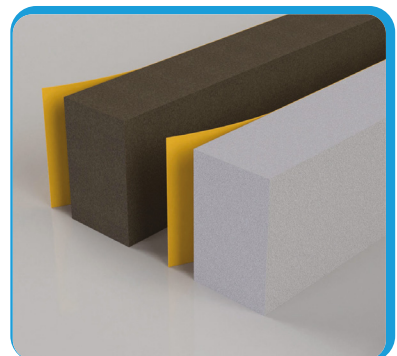

THRESHOLDS

SLIMLINE THRESHOLD DOOR SILL

> Product Description

A Slimline Threshold Door Sill by Stormguard for use on PVC, wood, composite and metal frames. This product can seal gaps up to 14mm. Available in an aluminium and gold colour and comes in 1000mm lengths. Designed to fit onto a subsill or directly onto a threshold.

Available in Aluminium and Matt Gold finish. Sold in 1000mm lengths

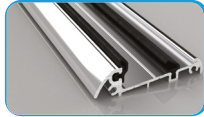
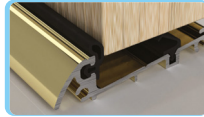

THRESHOLD SILL SG100

> Product Description

Stormguards SG100 threshold sill suitable for inward and outward opening doors. The SG100 seals gaps between 15 - 18mm and has a centre rubber seal. With pre-drilled drainage and concealed fixing holes.

Available in Aluminium or Gold effect colour. Sold in 1000mm or 1828mm lengths

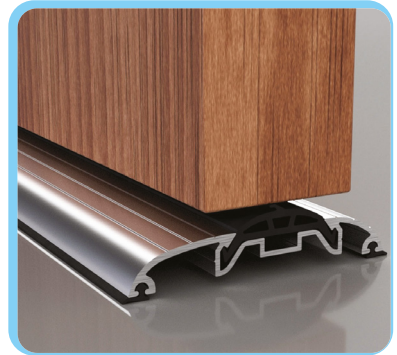
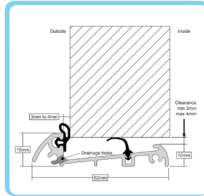

P PROFILE DOOR/GLAZING SEAL

> Product Description

A Lowline threshold seal by Stormguard that can seal gaps up to 27mm under the door. The seal is available in various colours and comes in 914mm lengths. Excellent performance under severe weather conditions ideal for inward opening doors.

Available in Aluminium and Gold finish
 Sold in 914mm lengths

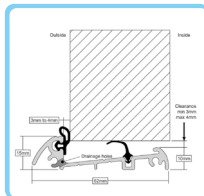

> How to order:

T: 01329 844 500 | E: SALES@ASTRODRAFT.COM

> For more information:

WWW.ASTRODRAFT.COM

UK Office: Astrodraft, Unit 14, The I.O. Centre, Stephenson Road,
Segensworth, Fareham, England PO15 5RU

T 01329 844 500
E sales@astrodraft.com
W www.astrodraft.com

16TH MAY 2024 Information correct at the time of going to print

Scan to view
the full range
of products



SCAN ME

AS PART OF OUR POLICY OF CONTINUING IMPROVEMENTS, WE RESERVE THE RIGHT TO MODIFY, ALTER OR CHANGE PRODUCT SPECIFICATIONS WITHOUT GIVING NOTICE. PRODUCT ILLUSTRATIONS ARE REPRESENTATIONS ONLY. ALL INFORMATION PROVIDED IS FOR GUIDANCE ONLY, AND AS ASTROFLAME (FIRE SEALS) LTD HAS NO CONTROL OVER THE SPECIFIC APPLICATION OR INSTALLATION METHODS OF THE PRODUCTS, OR OF THE PREVAILING SITE CONDITIONS, NO WARRANTIES EXPRESSED OR IMPLIED ARE INTENDED TO BE GIVEN AS TO THE ACTUAL PERFORMANCE OF THE PRODUCTS MENTIONED OR REFERRED TO, AND NO LIABILITY WHATSOEVER WILL BE ACCEPTED FOR ANY LOSS, DAMAGE OR INJURY ARISING FROM THE USE OF THE INFORMATION GIVEN OF PRODUCTS MENTIONED OR REFERRED TO HEREIN.

INFORMATION PROVIDED IS TO THE BEST OF OUR KNOWLEDGE TRUE AND ACCURATE AND BASED UPON CURRENT TEST DATA AND PRODUCT SPECIFICATION FROM THIRD PARTIES AND IS SUPPLIED FOR YOUR GUIDANCE ONLY. CUSTOMERS SHOULD SATISFY THEMSELVES TO THE SUITABILITY OF THE PRODUCT BASED ON THE PRODUCTS LIMITATION OF APPLICATIONS AND THAT THE PRODUCT IS FIT FOR PURPOSE FOR THEIR INTENDED USE AND NO GUARANTEE IS GIVEN OR IMPLIED SINCE THE CONDITIONS OF ACTUAL USE ARE BEYOND OUR CONTROL. ASTROFLAME (FIRE SEALS) LTD. DISCLAIM ANY LIABILITY FOR LOSS, DAMAGE OR OTHER EXPENSE ARISING FROM THE USE OF INFORMATION, DATA OR PRODUCTS MENTIONED OR REFERRED TO BY OURSELVES AND RESERVE THE RIGHT TO CHANGE ANY DETAILS OR SPECIFICATIONS WITHOUT NOTICE. IF YOU ARE IN ANY DOUBT AS TO THE SUITABILITY OF A PRODUCT FOR YOUR INTENDED APPLICATION PLEASE CONTACT OUR TECHNICAL TEAM ON 01329 844500 OR EMAIL SALES@ASTROFLAME.COM AND WE WILL CONTACT YOU.